

KomPal

Palettenregale



Die Stärke der Einfachheit

KomPal Palettenregal-System

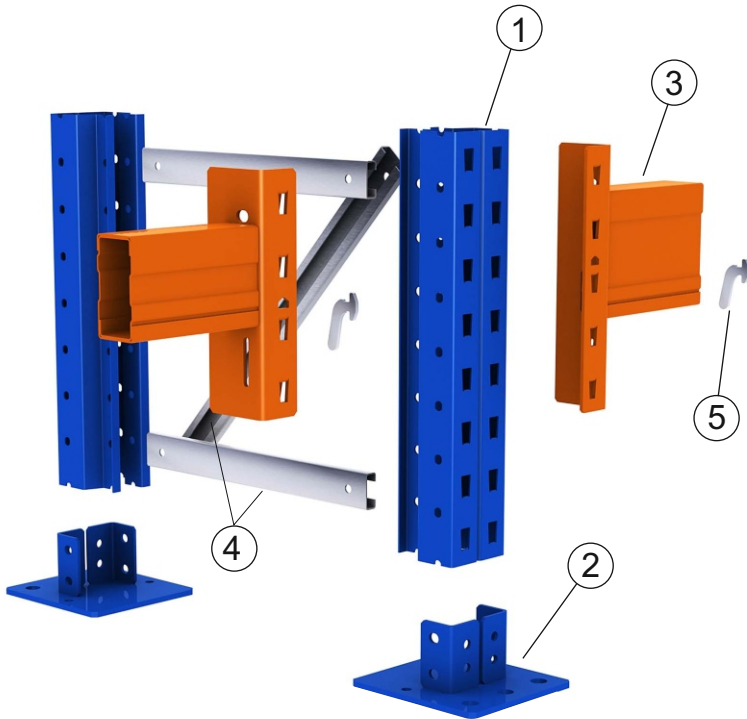

① Rahmenfeiler

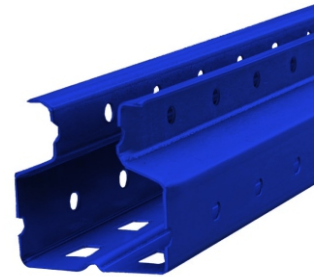

② Fussplatte (mm.)

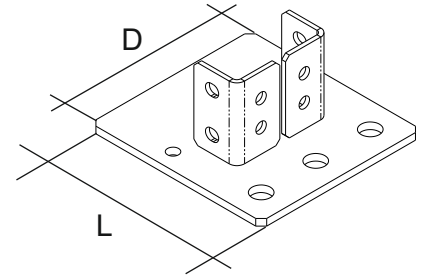

③ EGN Tragbalken



Ferbinder EC5

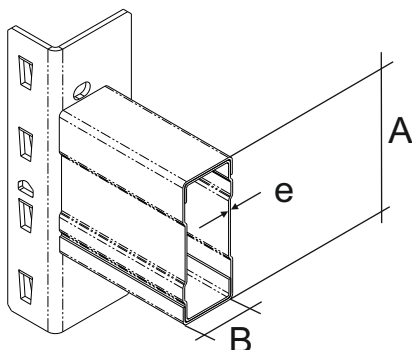

④ Horizontal- Diagonale CZ

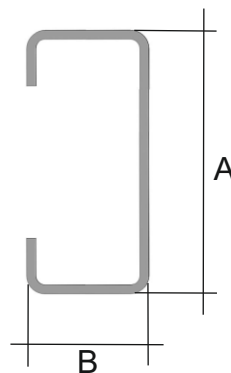

Typennummer	Abmessungen* (A x B)
CZ 36	36 x 13,6
CZ 42	42 x 25
CZ 50	50 x 32

*Abmessungen in mm.

⑤ Sicherungshaken

Oberfl. verzinkt





Traversentyp	Querschnitt* (A x B x e)	Länge
EGN 75x40x1,5	75 x 40 x 1,5	950-1350-1825-2250-2700
EGN 80x40x1,5	80 x 40 x 1,5	950-1350-1825-2250-2700
EGN 85x40x1,5	85 x 40 x 1,5	950-1350-1825-2250-2700
EGN 100x40x1,5	100 x 40 x 1,5	1825-2250-2700
EGN 100x50x1,5	100 x 50 x 1,5	1825-2250-2700-3300
EGN 116x40x1,5	116 x 40 x 1,5	2250-2700-3300
EGN 120x40x1,5	120 x 40 x 1,5	2250-2700-3300
EGN 120x50x1,5	120 x 50 x 1,5	2700-3600
EGN 135x40x1,5	135 x 40 x 1,5	2250-2700-3300-3600-3900
EGN 135x50x1,5	135 x 50 x 1,5	2700-3300-3600-3900
EGN 140x50x1,5	140 x 50 x 1,5	2700-3600-3900
EGN 140x50x2,0	140 x 50 x 2,0	3300-3600-3900
EGN 150x50x2,0	150 x 50 x 2,0	3300-3900
EGN 150x50x2,0	155 x 50 x 2,0	3300-3600-3900



Standard Farbe	Orange 2004
Beschichtung	verzinkt
	gelb 1007
	andere Farben auf Anfr.

*Abmessungen in mm.

*Abmessungen in mm.

Rahmenpfeiler 76M & 76A

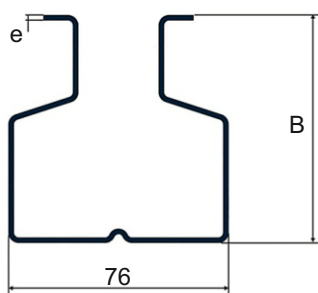

Description	Abmessungen* (76 x B x S)	Rahmen Profile	Fussplatte
ER76M15	76 x 63 x 1,5	CZ 36	RK6/76/A
ER76M18	76 x 63 x 1,8		
ER76M23	76 x 63 x 2,3		
ER76A15	76 x 79 x 1,5		
ER76A18	76 x 79 x 1,8		
ER76A20	76 x 79 x 2,0		
ER76A23	76 x 79 x 2,3		
ER76A25	76 x 79 x 2,5		

optional in verzinkt erhältlich

Rahmenpfeiler 100A & 100B

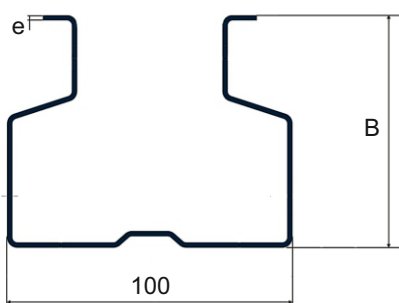

Typ	Abmessungen* (100 x B x S)	Rahmen Profile	Fussplatte
ER100A18	100 x 81 x 1,8	CZ 42	RK6/100/A
ER100A20	100 x 81 x 2,0		
ER100A23	100 x 81 x 2,3		
ER100A25	100 x 81 x 2,5		
ER100B18	100 x 105 x 1,8		RK6/100/B
ER100B20	100 x 105 x 2,0		
ER100B23	100 x 105 x 2,3		
ER100B25	100 x 105 x 2,5		
ER100B30	100 x 105 x 3,0		RK8/100/C

optional in verzinkt erhältlich

Rahmenpfeiler 115B & 115C

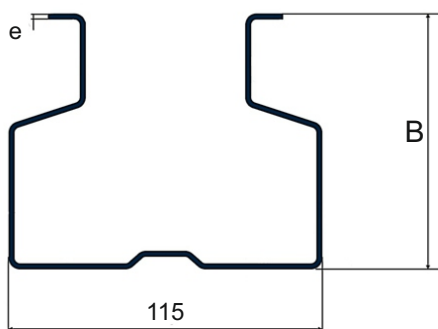

Typ	Abmessungen* (115 x B x S)	Rahmen Profile	Fussplatte
ER115B18	115 x 98 x 1,8	CZ 50	RK8/115/A
ER115B20	115 x 98 x 2,0		
ER115B23	115 x 98 x 2,3		
ER115B25	115 x 98 x 2,5		
ER115C20	115 x 126 x 2,0		
ER115C25	115 x 126 x 2,5		
ER115C30	115 x 126 x 3,0		
ER115C35	115 x 126 x 3,5		

optional in verzinkt erhältlich

Rahmentiefen (mm.) 800* - 900 - 1000 - 1100*

*Standard Tiefen.
Diagonalen und Querstreben: Oberfläche verzinkt.

Standardfarbe Blau 5019

verzinkte Oberfläche Materialstärke S
1,5 - 2,0 - 2,5 - 3,0

Maximale Belastung bei Tragbalkenquerschnitt von 75mm bis 80X40mm.

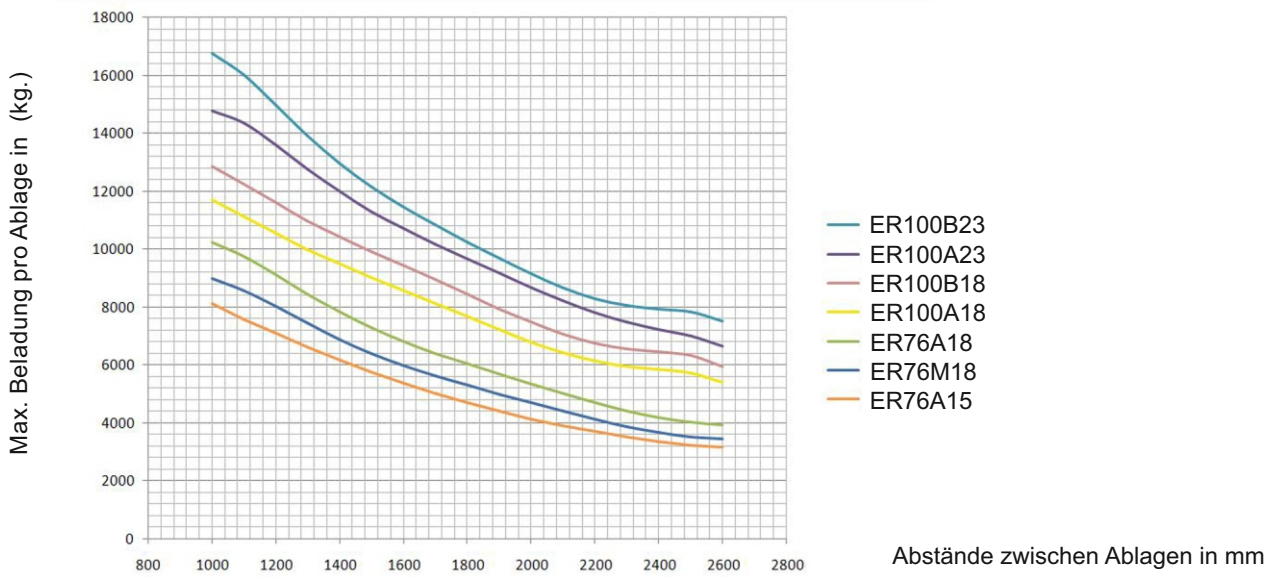

Maximale Belastung bei Tragbalkenquerschnitt von 85 X 40mm bis 100x40mm.

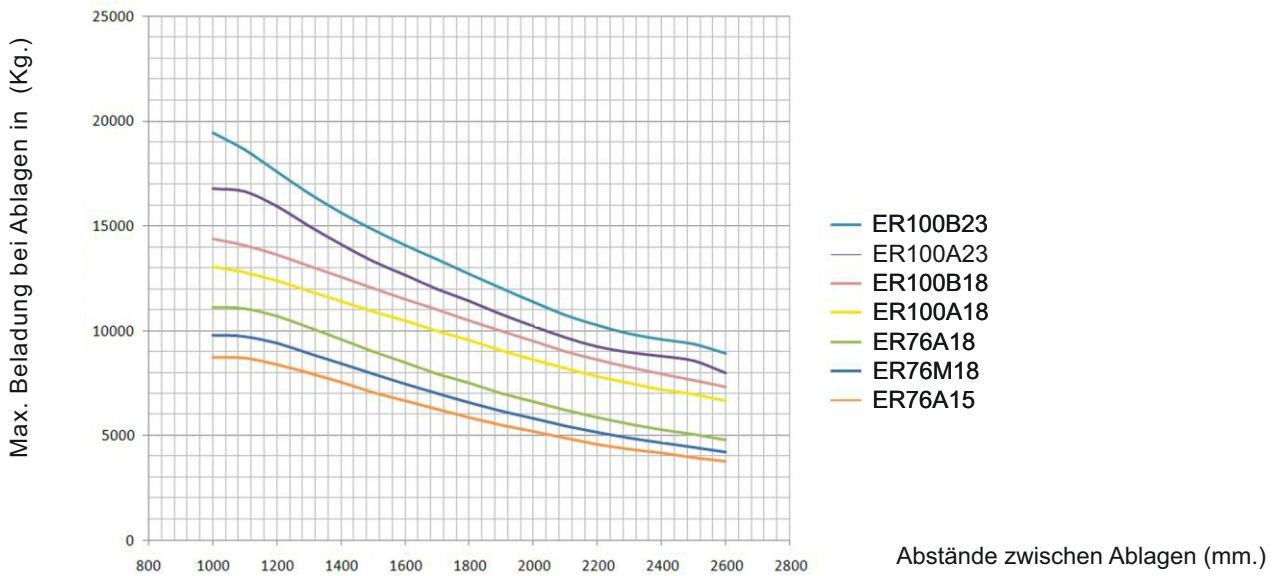

Maximale Belastung bei Tragbalkenquerschnitten über 100 X 40mm.

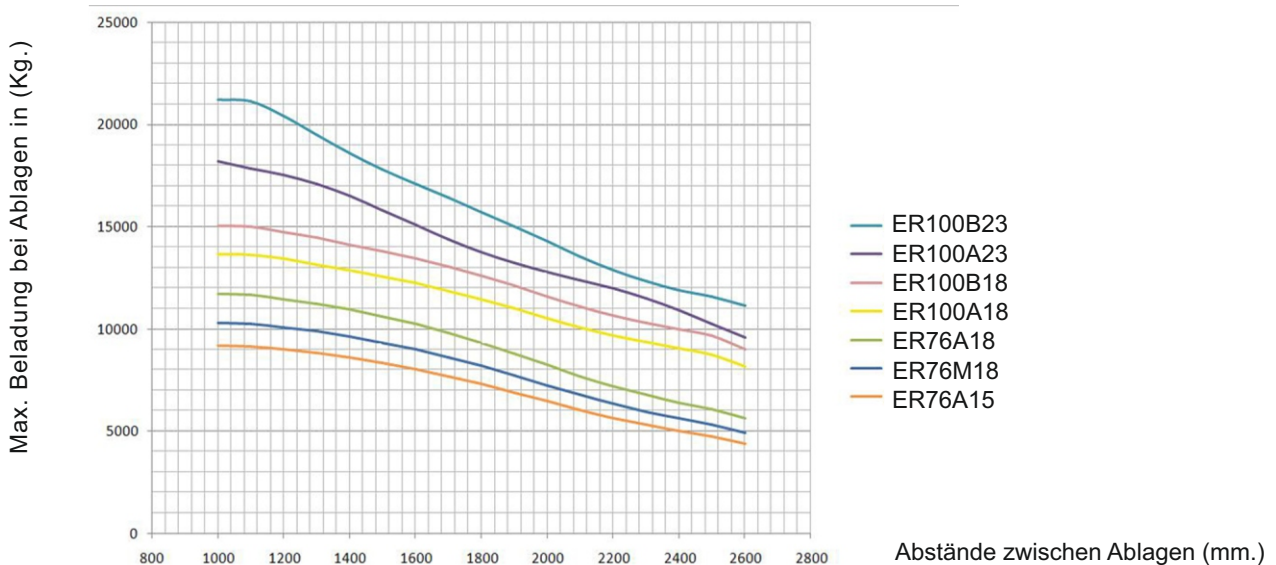

Zubehör

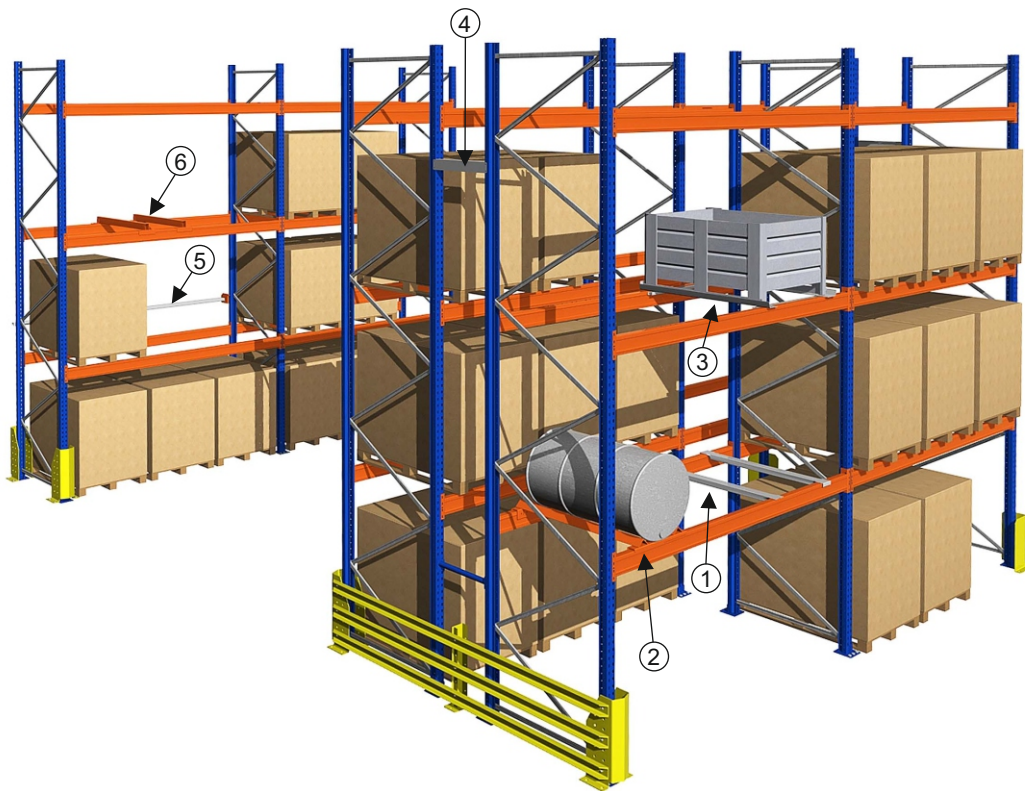

① **Querverbinder (Tragbalken)**

Mod: TPCZF

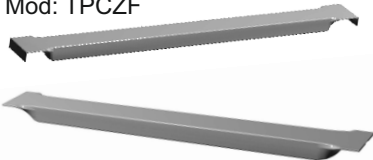

Mod: TPCZ

② **Fässer-Rahmen SB**

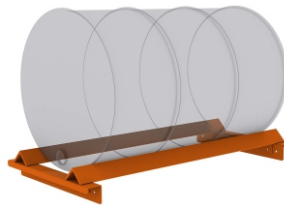

③ **Container Rahmen Sc1**



④ **Rahmen Abstandkonsolen**

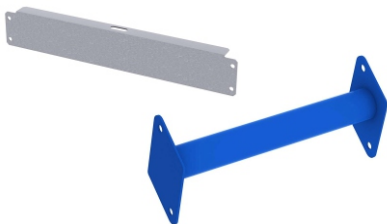

⑤ **Rückanschlagbalken LTC**

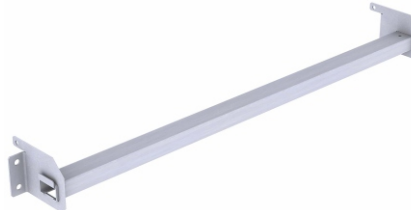

⑥ **Ober Palettenführung**



Regalverbinder (Gang)



Stahltablare (verzinkt)

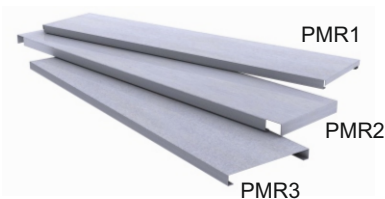

Rollenlager Rahmenanschluss



Gitter Tablar (Zwischen supports)

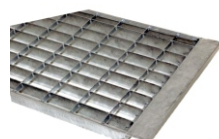

Gitter Tablar (über supports)

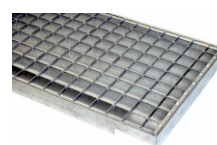

Schiffplatten

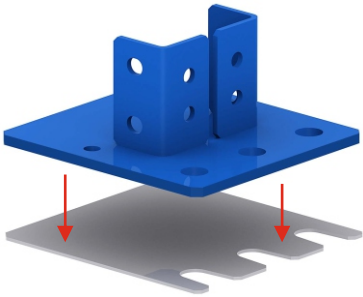
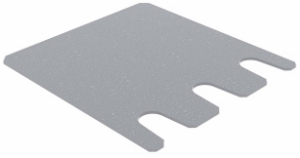

Z-Profile

zur fixierung der Spanplattenböden auf den Tragbalken.

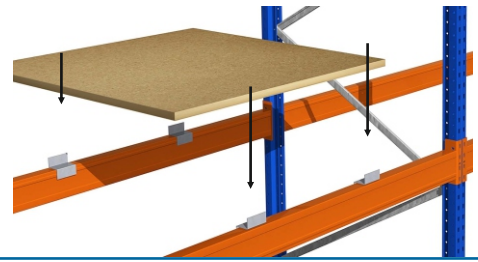
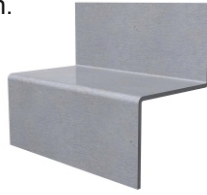

Spanplattenanschlag

zur Verwendung bei Querverbinder type TPCZF.

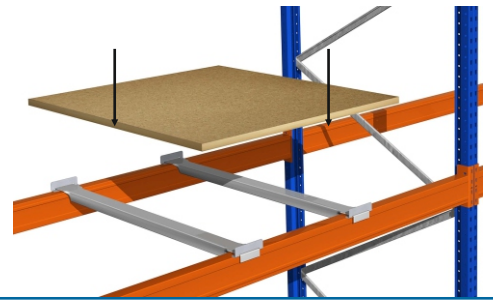
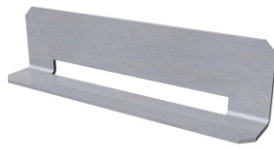

Einzel Rahmen Protetkor RK



Eck-Rahmen Protetkor DE



Doppel Rahmenprotetkor DIUD



Rahmenprotetkor ECO



Rahmenprotetkor Holzplanken Verticale Kreuzstreben



Horizontale Kreuzstreben



Gitter-Fallsicherung

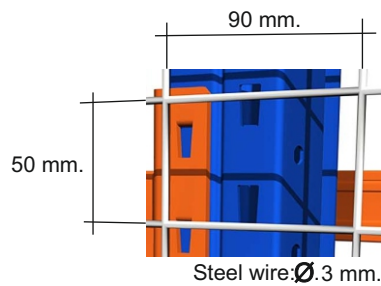

Rahmenerhöher

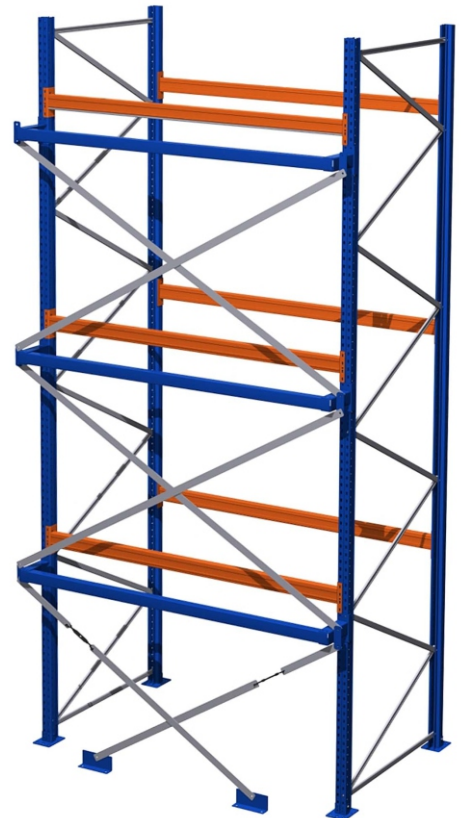
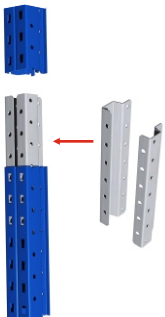

• Home

Portrait

Dienstleistungen

Take Away

Bestellung

Produkte

Kataloge

Referenzen

Galerie

Kontakt

KOMPATECH - Ihr Spezialist für Regale

Im Lager und Archiv, in Ausstellungen und Zuhause.



Wir freuen uns sehr über Ihren Besuch bei Kompatech. Hier finden Sie alle Infos über unsere Produkte und Dienstleistungen.

Unser höchstes Ziel ist die Kundenzufriedenheit.

Unsere grosse Stärke die Flexibilität.

Bleiben noch Fragen offen, scheuen Sie sich nicht uns zu [kontaktieren!](#)

Neu !!!

- Brauchen Sie ein günstiges Profi-Regal? Holen Sie es direkt bei uns ab! Mehr Infos unter [Take Away](#).
- Fahrzeugeinrichtungen StoreVan:



Kompatech GmbH

Bahnstrasse 164
8105 Regensdorf

Tel: (Direkt)
0041 43 299 03 35
(Kundendienst)
0041 43 299 03 36
Fax: 0041 43 299 03 37

email: info@kompatech.ch